

Body-Solid®

Built for Life

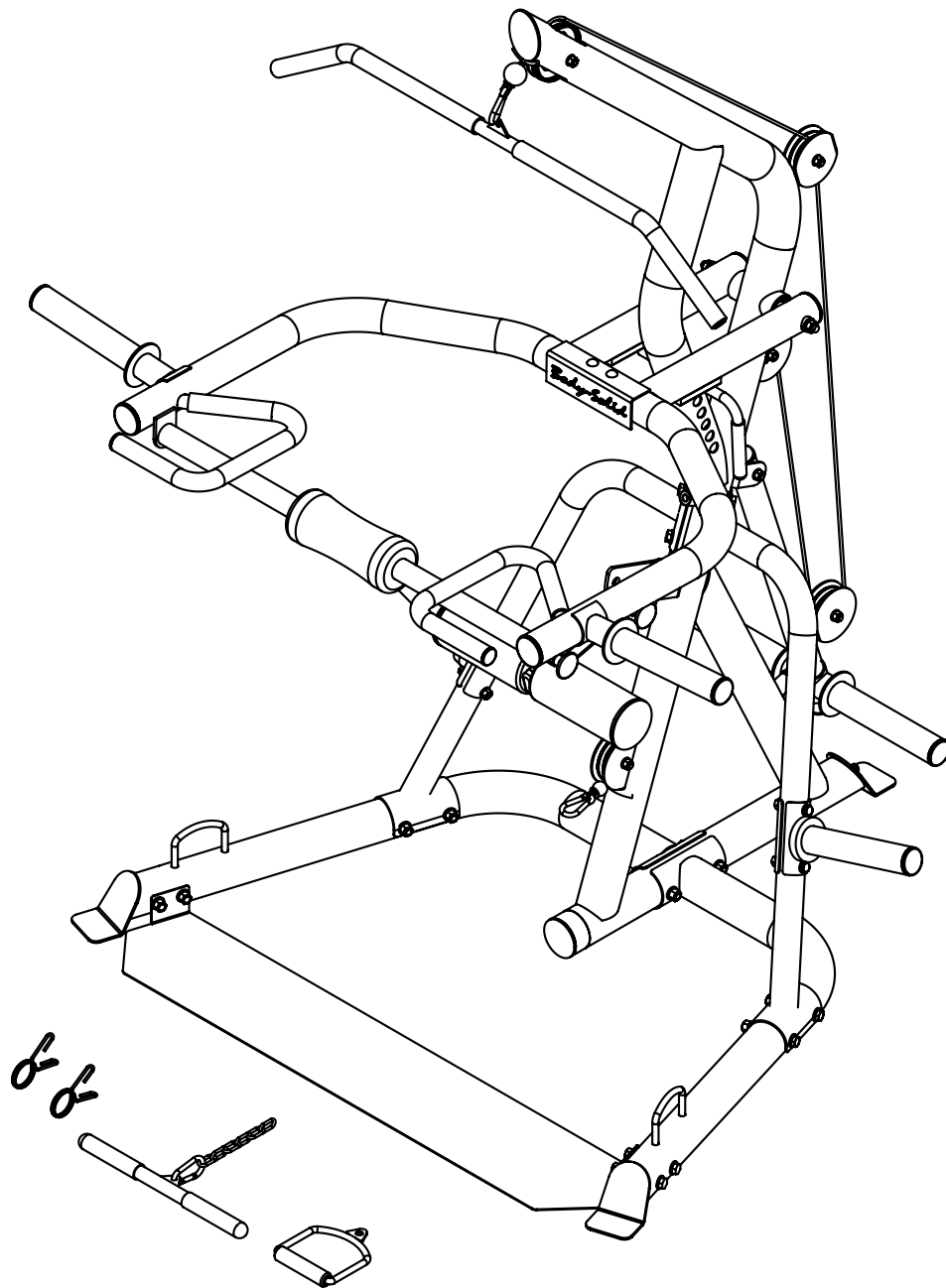

GLGS100

Assembly & Instructions

OWNER'S & MANUAL

V. GLGS100-102914

Warning, Safety & Maintenance

Be sure that all users carefully read and understand all warning, safety and maintenance labels on the machine before each use. Failure to do so may result in death or serious injury.

It is imperative that you retain this Owner's Manual and be sure all warning labels are legible and intact. Replacement Owner's Manuals and warning labels are available from your local Body-Solid dealer.

If you have any questions about the operation, set up or maintenance of this machine please call our customer service department at 1 (800) 556-3113.

THERE IS A RISK ASSUMED BY INDIVIDUALS WHO USE THIS TYPE OF EQUIPMENT. TO MINIMIZE RISK, YOU MUST FOLLOW THESE RULES:

1. Inspect equipment before each workout. Check that all nuts, bolts, screws and pop pins are in place and fully tightened. Also, before use, check cables for signs of wear. Replace all worn parts immediately. Never use machine if any parts are damaged or missing. **FAILURE TO FOLLOW THESE RULES MAY RESULT IN SERIOUS INJURY.**
2. Keep clear of the cables and all moving parts when the machine is in use.
3. Always make sure all Snap Links are closed when doing any cable/pulley/strap exercises.
4. Exercise with care. Perform your exercises at a smooth moderate pace; never perform jerky or uncoordinated movements that may cause injury.
5. It is recommended that you should workout with a training partner.
6. Do not allow children or minors to play on or around this equipment.
7. If unsure of proper use of equipment, call your local Body-Solid distributor or the Body-Solid customer service department at 1-800-556-3113.
8. **WARNING:** Consult your physician before starting your exercise program. For your own safety, do not begin any exercise program without proper instruction. RAL8-6-03 WC-54

WARNING

Safety and Maintenance of Cables

IMPORTANT: Cables are wear items. It is your responsibility to prevent unexpected breakage. **Cable inspection should be performed daily.** Inspect all cables, the nylon coating on all cables, and the area near the fitting at each end of each cable. **Replace any damaged or worn cable immediately.** Do not allow the machine to be used until damaged or worn cables are replaced. Using or allowing a machine to be used with a suspect cable can result in serious injury. See Owner's Manual for more information.

For Body-Solid Customer Service
Call 1-800-556-3113

MAINTENANCE SCHEDULE		D A I L Y	W E E K L Y
Check the function and integrity of the following components. As noted, inspect equipment before each workout. Replace all damaged, broken or worn components immediately.			
Cables:	Check tension, end fittings, and coating	✓	
	Check that locking nut at weight stack is tight		✓
Upholstery:	Wipe down and dry	✓	
	Clean and condition		✓
Frame:	Wipe down and dry	✓	
	Polish / Wax		✓
Chrome:	Wipe down and dry	✓	
	Polish / Lubricate		✓
Nuts / Bolts / Fasteners:	Tighten and / or adjust as needed		✓
Guide Rods:	Lubricate and clean		✓
Linear Rods:	Lubricate and clean		✓
Seat Sleeves:	Lubricate and clean		✓
Adjustments / Locking Pins / Tightening Knobs			✓
Weight Stack Pins			✓
Warning Instruction Labels			✓
Springs / Pop Pins		✓	
Anti Skid Surfaces			✓
Hand Grips / Rollers			✓

For Body-Solid Customer Service
Call 1-800-556-3113
#MSSTKR0803

Table of Contents

- SAFETY INSTRUCTIONS..... PAGE 4
- PREPARATION..... PAGE 5
- HARDWARE ILLUSTRATION..... PAGE 6
- PART / HARDWARE LIST..... PAGE 10
- ASSEMBLY INSTRUCTIONS..... PAGE 12
- EXPLODED VIEW..... PAGE 23
- CONTACT PAGE..... PAGE 24

Important Safety Instructions

Before beginning any fitness program, you should obtain a complete physical examination from your physician.

*Il est conseillé de subir un examen médical complet avant d'entreprendre tout programme d'exercice.
Si vous avez des étourdissements ou des faiblesses, arrêtez les exercices immédiatement.*

Antes de comenzar cualquier programa de ejercicios, deberías tener un examen físico con su doctor.

When using exercise equipment, you should always take basic precautions, including the following:

- Read all instructions before using the **GLGS100**. These instructions are written to ensure your safety and to protect the unit.
- **Do not remove any safety labels from the machine.**
- Do not allow children on or near the equipment.
- Use the equipment only for its intended purpose as described in this guide. Do not use accessory attachments that are not recommended by the manufacturer. Such attachments might cause injuries.
- Wear proper exercise clothing and shoes for your workout, no loose clothing.
- Keep hands, limbs, loose clothing, and long hair well out of the way of all moving parts.
- Use care when getting on or off the unit.
- Do not overexert yourself or work to exhaustion.
- If you feel any pain or abnormal symptoms, stop your workout immediately and consult your physician.
- Never operate unit when it has been dropped or damaged. Return the equipment to a service center for examination and repair.
- Never drop or insert objects into any opening in the equipment.
- Always check the unit and its cables before each use. Make sure that all fasteners and cables are secure and in good working condition.
- Do not use the equipment outdoors or near water.

Personal Safety During Assembly

- Before beginning assembly, please take the time to read the instructions thoroughly.
- Read each step in the assembly instructions and follow the steps in sequence. Do not skip ahead. If you skip ahead, you may learn later that you have to disassemble components and that you may have damaged the equipment.
- Assemble and operate the **GLGS100** on a solid, level surface. Locate the unit a few feet from the walls or furniture to provide easy access.

The **GLGS100** is designed for your enjoyment. By following these precautions and using common sense, you will have many safe and pleasurable hours of healthful exercise with your Body-Solid **LEVERAGE GYM SYSTEM**.

After assembly, you should check all functions to ensure correct operation. If you experience problems, first recheck the assembly instructions to locate any possible errors made during assembly. If you are unable to correct the problem, call the dealer from whom you purchased the machine or call **1-800-556-3113** for the dealer nearest you.

Obtaining Service

Please use this Owner's Manual to make sure that all parts have been included in your shipment. When ordering parts, you must use the part number and description from this Owner's Manual. Use only Body-Solid replacement parts when servicing this machine. Failure to do so will void your warranty and could result in personal injury.

For information about product operation or service, check out the official Body-Solid website at www.bodysolid.com or contact an authorized Body-Solid dealer or a Body-Solid factory-authorized service company or contact Body-Solid customer service at one of the following:

Toll Free: 1-800-556-3113
Phone: 1-708-427-3555
Fax: 1-708-427-3556
Hours: M-F 8:30-5:00 CST
E-Mail: service@bodysolid.com

**Or write to: Body-Solid, Inc.
Service Department
1900 S. Des Plaines Ave.
Forest Park, IL 60130 USA**

Retain this Owner's Manual for future reference. If you need to order replacement parts please be prepared to provide the following information when contacting us so that we can assist you better.

- 1. Model Number**
- 2. Place of Purchase**
- 3. Serial Number (S/N)**
- 4. Part # and Description**

Preparation

Thank you for purchasing the **GLGS100**. This Product is part of the Body-Solid line of quality strength training machines, which lets you target specific muscle groups to achieve better muscle tone and overall body conditioning. To maximize your use of the equipment please study this Owner's Manual thoroughly.

Required Tools

The basic tools that you must obtain before assembling the **GLGS100** include but are not limited to:

- Standard Wrench Set
- Metric Wrench Set
- Adjustable Wrench

Installation Requirements

Follow these installation requirements when assembling the **GLGS100**: Set up the **GLGS100** on a solid, flat surface. A smooth, flat surface under the machine helps keep it level. A level machine has fewer malfunctions.

Provide ample space around the machine. Open space around the machine allows for easier access.

Insert all bolts in the same direction. For aesthetic purposes, insert all bolts in the same direction unless specified (in text or illustrations) to do otherwise.

Leave room for adjustments. Tighten fasteners such as bolts, nuts, and screws so the unit is stable, but leave room for adjustments. Do not fully tighten fasteners until instructed in the assembly steps to do so.

Fill out and mail the warranty card.

Assembly Tips

Read all "Notes" on each page before beginning each step.

While you may be able to assemble the **GLGS100** using the illustrations only, important safety notes and other tips are included in the text.

Some pieces may have extra holes that you will not use. Use only those holes indicated in the instructions and illustrations.

NOTE: With so many assembled parts, proper alignment and adjustment is critical. While tightening the nuts and bolts, be sure to leave room for adjustments.

NOTE: The bottles that are marked "Poison" is your touch up paint. Keep away from children.

CAUTION: Obtain assistance! If you feel like you can't assemble the **GLGS100** by yourself then do not attempt to do so as this could result in injury. Review the installation requirements before proceeding with the following steps.

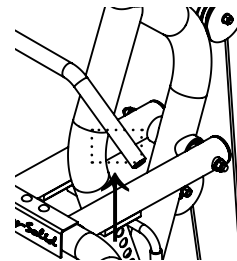

Your S/N# can
be found here

Body-Solid continually seeks ways to improve the performance, specifications and product manuals in order to ensure that only superior products are released from our factories. Please take the time to carefully read through this manual thoroughly. Instructions contained in this document are not intended to cover all details or variations possible with Body-Solid equipment, or to cover every contingency that may be met in conjunction with installation, operation, maintenance or troubleshooting of the equipment. Even though we have prepared this manual with extreme care, neither the publisher nor the author can accept responsibility for any errors in, or omission from, the information given. Should additional information be required, or should situations arise that are not covered by this manual, the matter should be directed to your local Body-Solid representative, or the Service Department at Body-Solid Inc. in Forest Park, Illinois.

GLGS100 Hardware Illustration

Part #1

HEX HEAD BOLT M12x100mm

QTY. 10

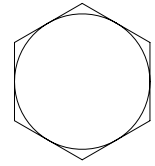
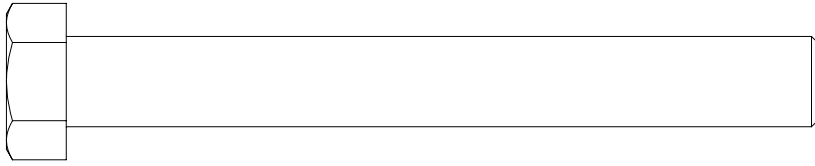

Part #2

HEX HEAD BOLT M12x25mm

QTY. 8

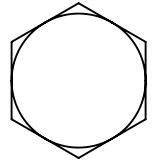
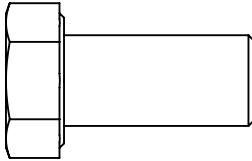

Part #3

HEX HEAD BOLT M10x90mm

QTY. 1

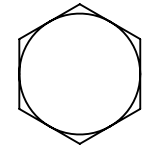
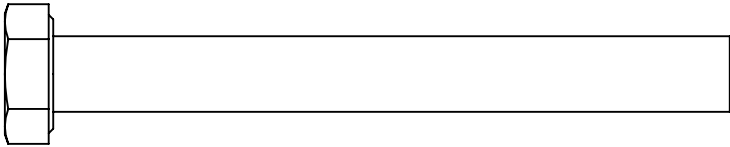

Part #4

HEX HEAD BOLT M10x80mm

QTY. 1

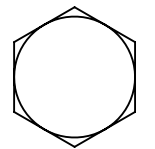
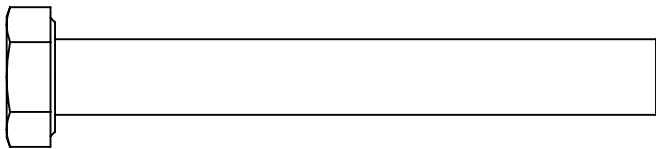

Part #5

CARRIAGE BOLT M10x75mm

QTY. 2

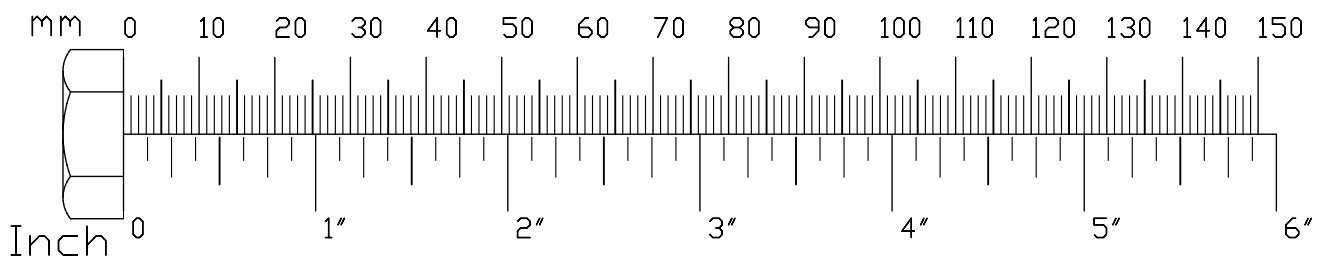
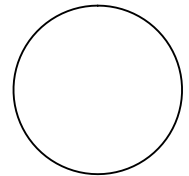
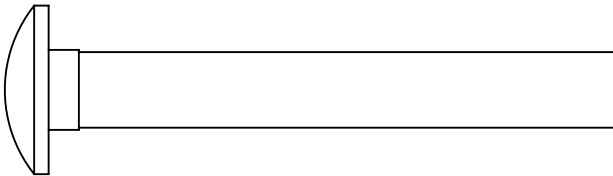

GLGS100 Hardware Illustration

Part #6

HEX HEAD BOLT M10x70mm

QTY. 5

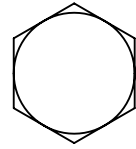
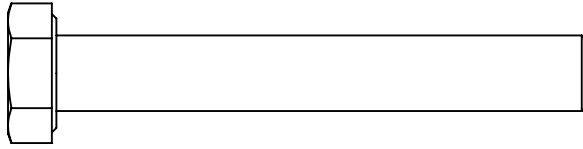

Part #7

HEX HEAD BOLT M10x50mm

QTY. 4

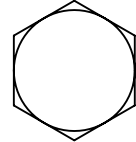
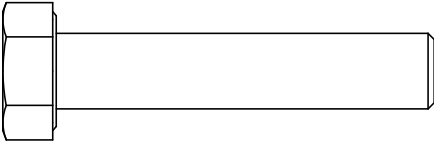

Part #8

BUTTON HEAD CAP SCREW M10x20mm

QTY. 4

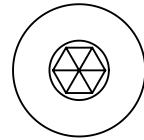
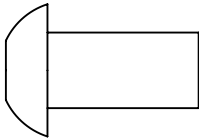

Part #9

BUTTON HEAD CAP SCREW M6x20mm

QTY. 2

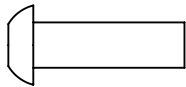

Part #10

FLAT HEAD PHILLIPS SCREW M4x20mm

QTY. 6

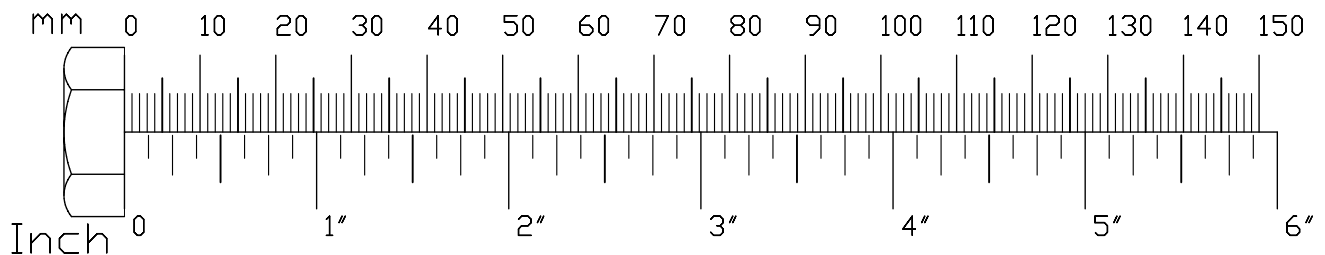
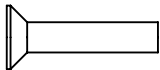

GLGS100 Hardware Illustration

Part #11

SET SCREW M10x25mm

QTY. 2

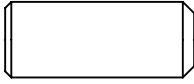

Part #12

NYLON LOCK NUT M12

QTY. 12

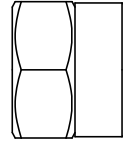
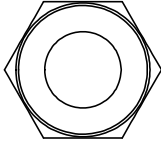

Part #13

NYLON LOCK NUT M10

QTY. 13

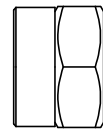
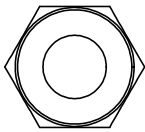

Part #14

FLAT WASHER M12

QTY. 30

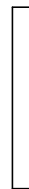
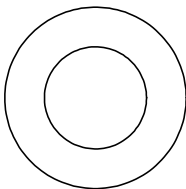

Part #15

FLAT WASHER M10

QTY. 24

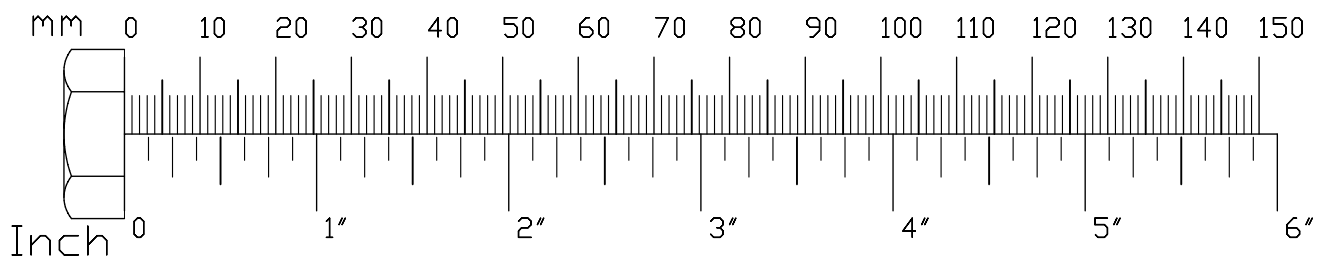
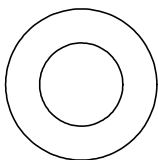

GLGS100 Hardware Illustration

Part #16

LOCK WASHER M10

QTY. 4

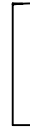
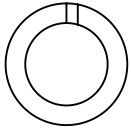

Part #17

LARGE O.D. FLAT WASHER M10

QTY. 4

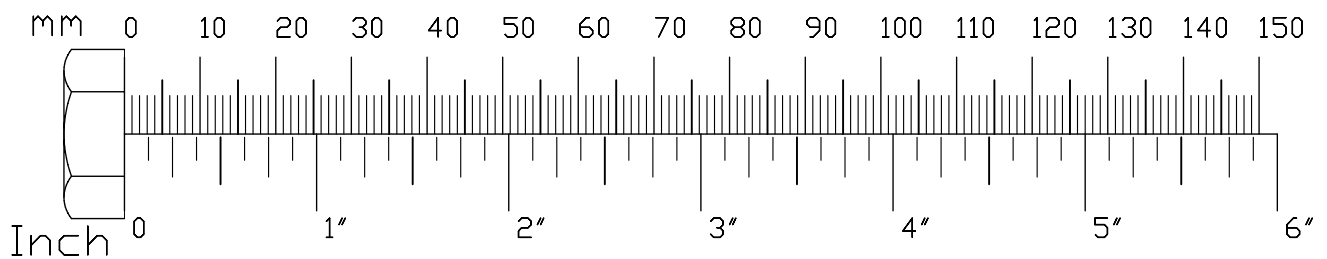
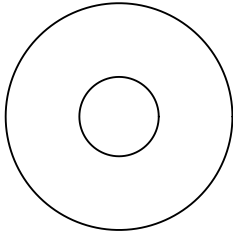

GLGS100 Parts & Hardware List

Part#	Qty	Description
A	1	LOWER UPRIGHT
B	1	RIGHT BASE FRAME
C	1	LEFT BASE FRAME
D	1	FOOT PLATE
E	1	LEFT SUPPORT FRAME
F	1	RIGHT SUPPORT FRAME
G	1	RIGHT PRESS ARM
H	1	LEFT PRESS ARM
J	1	WEIGHT ROTATING TUBE
K	1	UPPER UPRIGHT
L	1	SQUAT BAR
M	1	LAT BAR
N	1	LOW BAR
P	1	CHROME HANDLE
Q	2	CHROME WEIGHT HORN
R	4	CHROME WEIGHT HORN
S	1	LOGO PLATE
T	1	ADJUSTMENT BAR
U	2	STEEL PLATE
V	1	KNEE LOCK TUBE
W	1	ROUND TUBE
1	10	M12x100mm HEX HEAD BOLT
2	8	M12x25mm HEX HEAD BOLT
3	1	M10x90mm HEX HEAD BOLT
4	1	M10x80mm HEX HEAD BOLT
5	2	M10x75mm CARRIAGE BOLT
6	5	M10x70mm HEX HEAD BOLT
7	4	M10x50mm HEX HEAD BOLT
8	4	M10x20mm BUTTON HEAD CAP SCREW
9	2	M6x20mm BUTTON HEAD CAP SCREW
10	6	M4x20mm FLAT HEAD PHILLIPS SCREW
11	2	M10x25mm SET SCREW
12	12	M12 NYLON LOCK NUT
13	13	M10 NYLON LOCK NUT
14	30	M12 FLAT WASHER

GLGS100 Parts & Hardware List

Part#	Qty	Description
15	24	M10 FLAT WASHER
16	4	M10 LOCK WASHER
17	4	M10 LARGE O.D. FLAT WASHER
18	8	PULLEY SPACER Ø15xØ11x5mm
19	2	PULLEY SPACER Ø15xØ11x25mm
20	1	PULLEY Ø110mm
21	4	PULLEY Ø90mm
22	2	LOW BAR GRIP
23	2	SPRING COLLAR
24	3	SNAP LINK
25	1	CHAIN
26	2	BUSHING
27	1	POP PIN, Ø12.5x56mm
28	2	KNEE LOCK FOAM ROLLER
29	2	ROUND END CAP, Ø95mm
30	2	RUBBER BUMPER
31	2	RUBBER DONUT
32	8	ROUND END CAP, Ø50mm
33	1	SQUAT FOAM ROLLER
34	2	SQUAT FOAM GRIP
35	2	PRESS ARM GRIP
36	2	ROUND END CAP, Ø25mm
37	4	ROUND END CAP, Ø60mm
38	1	LOGO DECAL
39	2	LAT BAR GRIP
40	2	SNAP RING, Ø50mm OD
41	2	BEARING, Ø45xØ20x14mm
42	1	SHAFT
43	1	BAR GRIP
44	1	CABLE
45	1	POP PIN, Ø18x55mm
46	2	OVAL END CAP, 25x50mm
47	2	KNEE LOCK FOAM ROLLER COVER
48	1	SQUAT FOAM ROLLER COVER

STEP**1**

Be careful to assemble all components in the sequence they are presented.

NOTE:

Finger tighten all hardware in this step. **DO NOT** wrench tighten until instructed. Some components may be pre-assembled. Nylon lock nuts will not fully screw onto bolts, they must be wrench tighten to fully go on.

- 1A.** Attach Left & Right Base Frames (**B & C**) to LOWER UPRIGHT (**A**) using:
- 2 - (#1) M12x100mm Hex Head Bolt**
 - 4 - (#14) M12 Flat Washer**
 - 2 - (#12) M12 Nylon Lock Nut**
- 1B.** Attach Foot Plate (**D**) to Left & Right Base Frames (**B & C**) using:
- 4 - (#1) M12x100mm Hex Head Bolt**
 - 8 - (#14) M12 Flat Washer**
 - 4 - (#12) M12 Nylon Lock Nut**

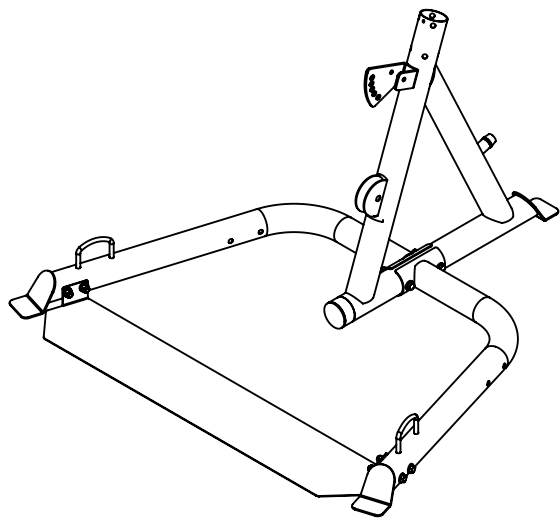

Above shows Step 1 assembled and completed.

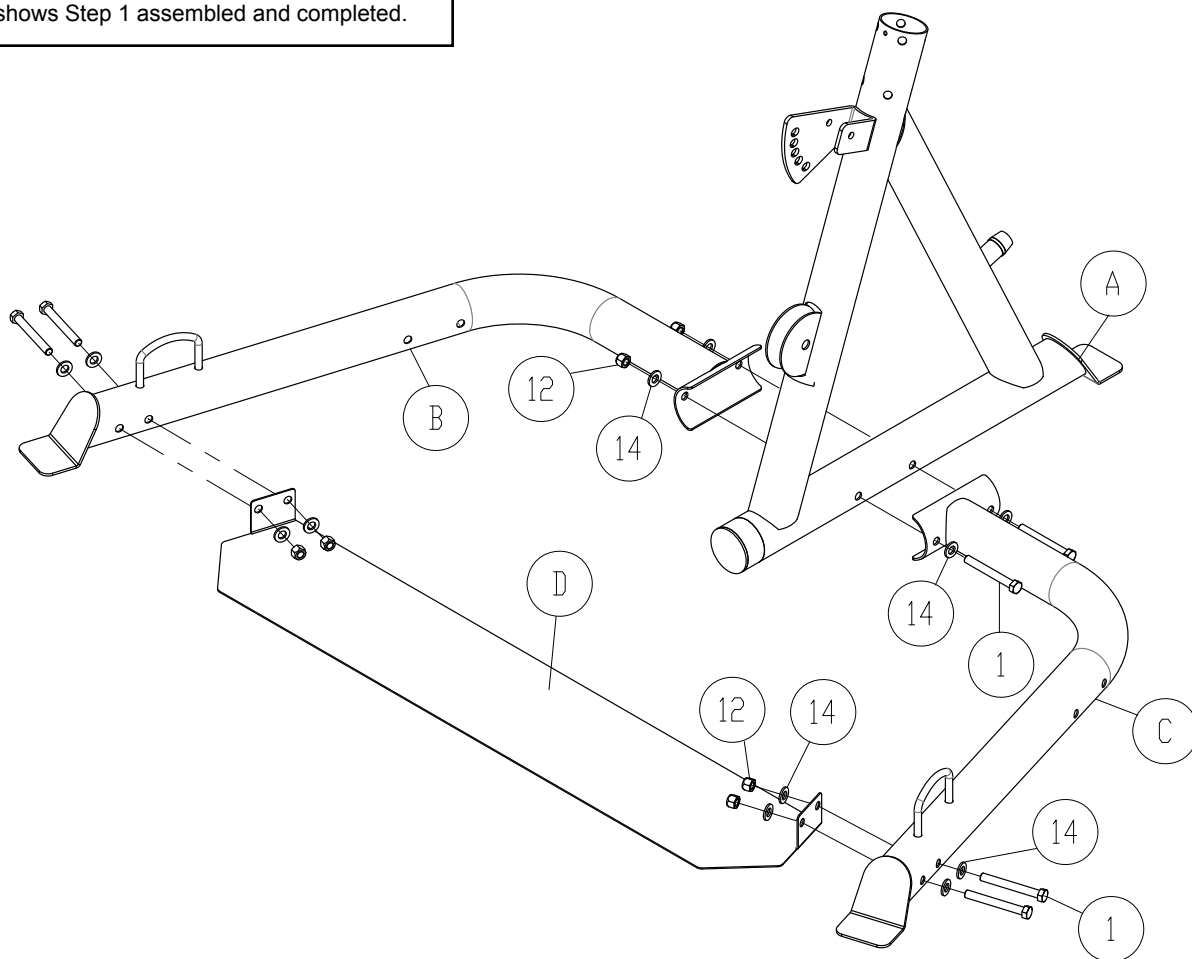

STEP**2**

Be careful to assemble all components in the sequence they are presented.

NOTE:

Finger tighten all hardware first in this step. Wrench tighten ALL hardware at the end of STEP 2D. Some components may be pre-assembled. Nylon lock nuts will not fully screw onto bolts, they must be wrench tighten to fully go on.

- 2A.** Attach Left & Right Support Frames (**F & E**) to Left & Right Base Frame (**B & C**) using:
- 4 - (#1) M12x100mm Hex Head Bolt
 - 8 - (#14) M12 Flat Washer
 - 4 - (#12) M12 Nylon Lock Nut
- 2B.** Attach Upper Upright (**K**) to Lower Upright (**A**), Left & Right Support Frames (**F & E**) using:
- 8 - (#2) M12x25mm Hex Head Bolt
 - 8 - (#14) M12 Flat Washer
- 2C.** Attach Rubber Bumper (**30**) to Lower Upright (**A**) using:
- 1 - (#9) M6x20mm Button Head Cap Screw
- 2D.** Route Cable (**44**) and Install one Ø110mm Pulley (**20**) and three Ø90mm Pulleys (**21**) on Uprights (**A & K**) per Step 2 Drawing using:
- 1 - (#3) M10x90mm Hex Head Bolt
 - 3 - (#7) M10x50mm Hex Head Bolt
 - 4 - (#13) M10 Nylon Lock Nut
 - 8 - (#15) M10 Flat Washer
 - 6 - (#18) Pulley Spacer Ø15xØ11x5mm
 - 2 - (#19) Pulley Spacer Ø15xØ11x25mm

NOTE:

1. A Hook is provided to assist you to fish the Cable out of the Lower Upright.
2. Before wrench tightening the hardware, please make sure the machine is leveled and the upright is straight.

STEP**3**

Be careful to assemble all components in the sequence they are presented.

NOTE:

Finger tighten all hardware first in this step. Wrench tighten ALL hardware at the end of STEP 3F. Some components may be pre-assembled. Nylon lock nuts will not fully screw onto bolts, they must be wrench tighten to fully go on.

- 3A.** Attach Weight Rotating Tube (**J**) to Upper Upright (**K**) using:
1 - (#4) M10x80mm Hex Head Bolt
2 - (#15) M10 Flat Washer
2 - (#26) Bushing
1 - (#13) M10 Nylon Lock Nut
- 3B.** Attach two Chrome Weight Horns (**R**) to Weight Rotating Tube (**J**) using:
2 - (#8) M10x20mm Button Head Cap Screw
2 - (#16) M10 Lock Washer
2 - (#17) M10 Large O.D. Flat Washer
- 3C.** Insert two Round End Caps (**32**) to two Chrome Weight Horns (**R**).
- 3D.** Attach two Chrome Weight Horns (**Q**) to Left & Right Support Frames (**F & E**) using:
4 - (#6) M10x70mm Hex Head Bolt
8 - (#15) M10 Flat Washer
4 - (#13) M10 Nylon Lock Nut
- 3E.** Insert Round End Caps (**32**) & Rubber Donuts (**31**) onto Chrome Weight Horns (**Q**)
- 3F.** Attach Knee Lock Tube (**V**) to Lower Upright (**A**) using:
1 - (#6) M10x70mm Hex Head Bolt
2 - (#15) M10 Flat Washer
1 - (#13) M10 Nylon Lock Nut
- 3G.** Insert Round Tube (**W**) onto Knee Lock Tube (**V**)
- 3H.** Insert two Knee Lock Foam Rollers (**28**) and two Round End Caps (**29**) onto Round Tube (**W**).

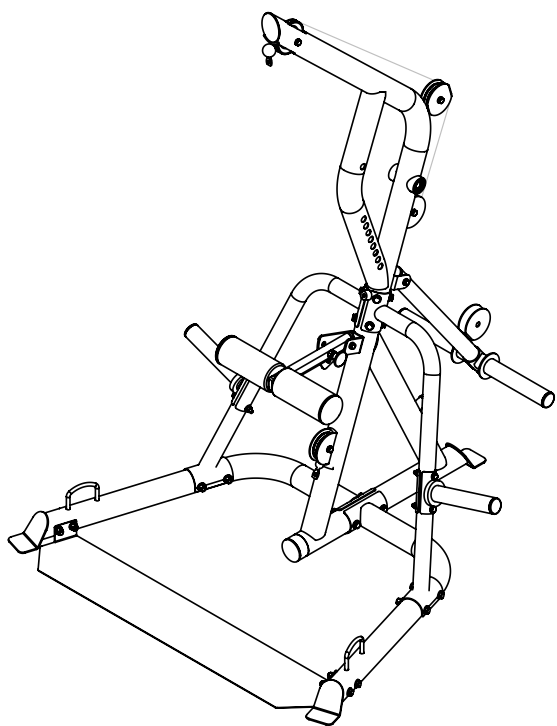

Above shows Step 3 assembled and completed.

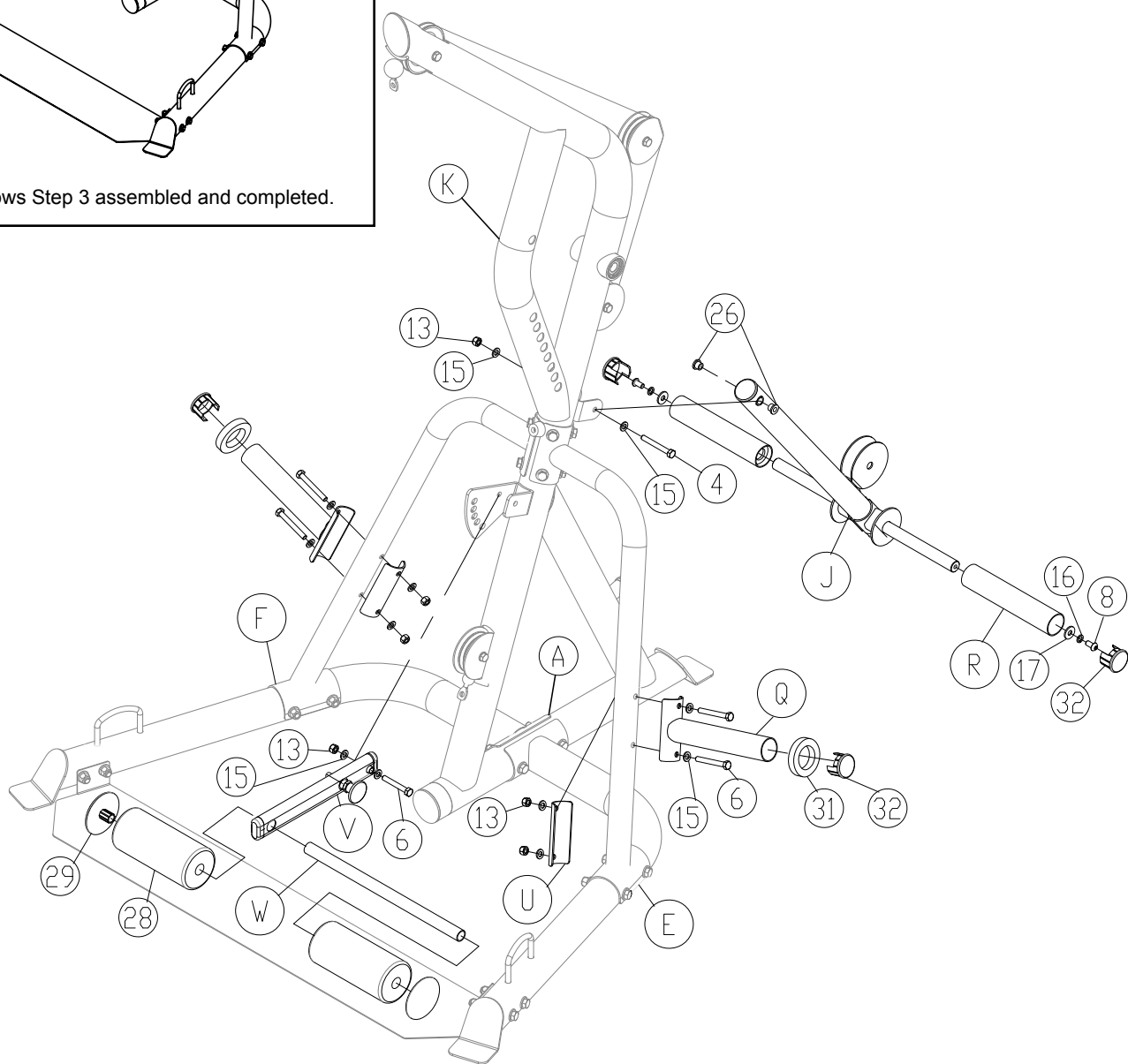

STEP**4**

Be careful to assemble all components in the sequence they are presented.

NOTE:

Finger tighten all hardware first in this step. Wrench tighten ALL hardware at the end of STEP 4E. Some components may be pre-assembled. Nylon lock nuts will not fully screw onto bolts, they must be wrench tighten to fully go on.

- 4A.** Route Cable (**44**) and install one Ø90mm Pulleys (**21**) on Weight Rotating Tube (**J**) per Step 4 Drawing using:
- 1 - (#7) M10x50mm Hex Head Bolt
 - 1 - (#13) M10 Nylon Lock Nut
 - 2 - (#15) M10 Flat Washer
 - 2 - (#18) Pulley Spacer Ø15xØ11x5mm
- 4B.** Attach Press Arms (**G & H**) and Logo Plate (**S**) together using:
- 2 - (#5) M10x75mm Carriage Bolt
 - 2 - (#15) M10 Flat Washer
 - 2 - (#13) M10 Nylon Lock Nut
- 4C.** Attach Press Arms (**G & H**) to Upper Upright (**K**) using:
- 1 - (#42) Shaft
 - 2 - (#14) M12 Flat Washer
 - 2 - (#12) M12 Nylon Lock Nut
- 4D.** Insert Adjustment Bar (**T**) into one of the adjustment holes of Upper Upright (**K**) to support Press Arms (**G & H**).
- 4E.** Attach two Chrome Weight Horns (**R**) to Press Arms (**G & H**) using:
- 2 - (#8) M10x20mm Button Head Cap Screw
 - 2 - (#16) M10 Lock Washer
 - 2 - (#17) M10 Large O.D. Flat Washer
- 4F.** Insert two Round End Caps (**32**) onto two Chrome Weight Horns (**R**).

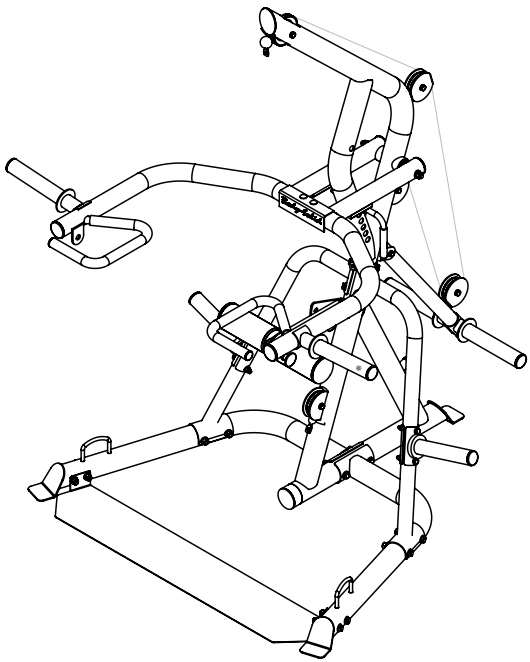

Above shows Step 4 assembled and completed.

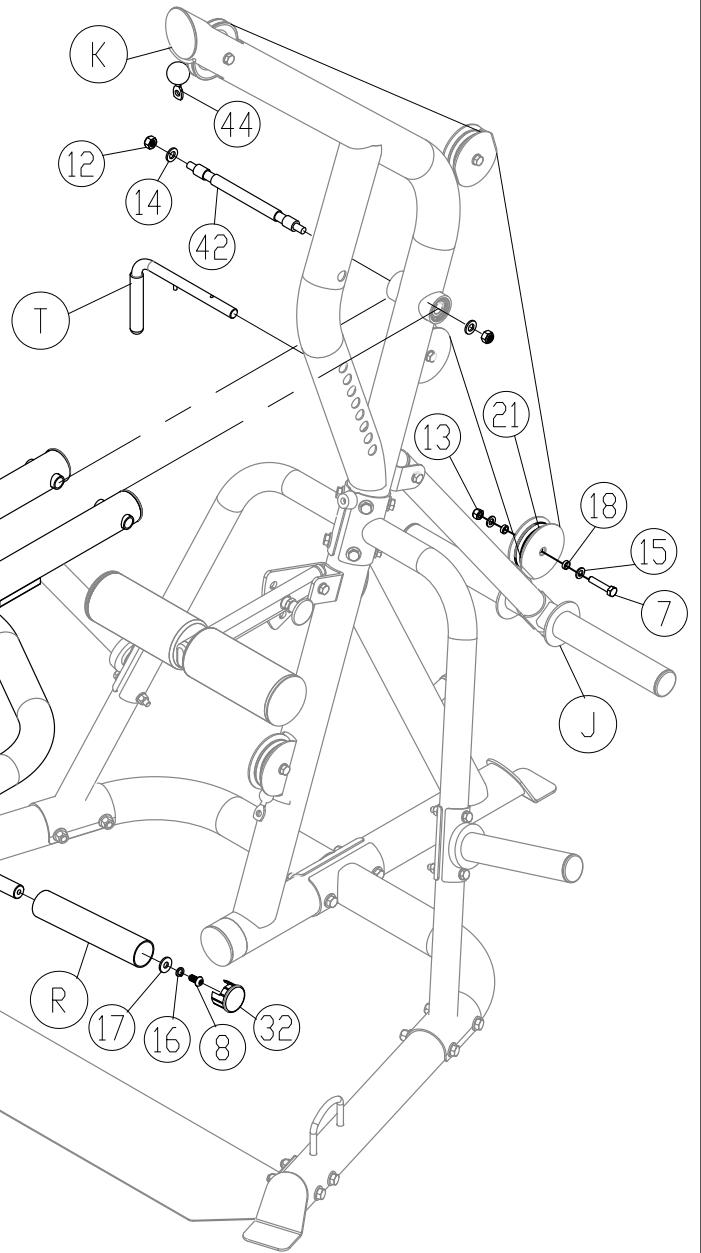

STEP**5**

Be careful to assemble all components in the sequence they are presented.

- 5A.** Attach Lat Bar (**M**) to the top of the Cable (**44**).
- 5B.** Attach Squat Bar (**L**) to the Press Arms (**G & H**).
- 5C.** Attach either Low Bar (**N**) or Chrome Handle (**P**) to the bottom of the Cable (**44**).

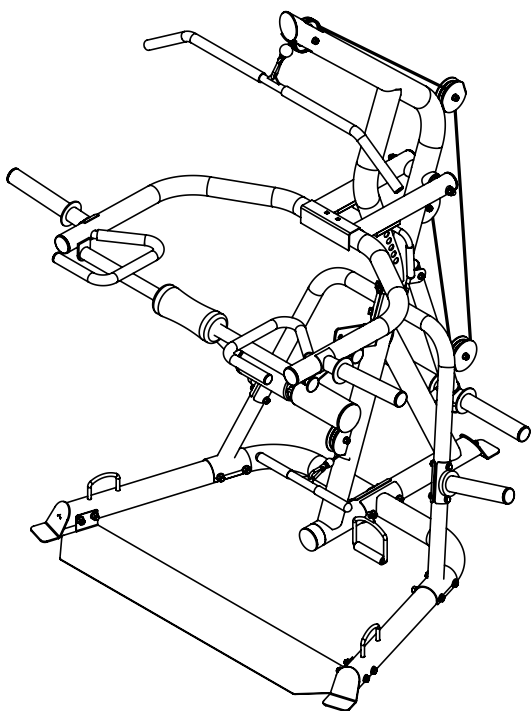

Above shows Step 5 assembled and completed.

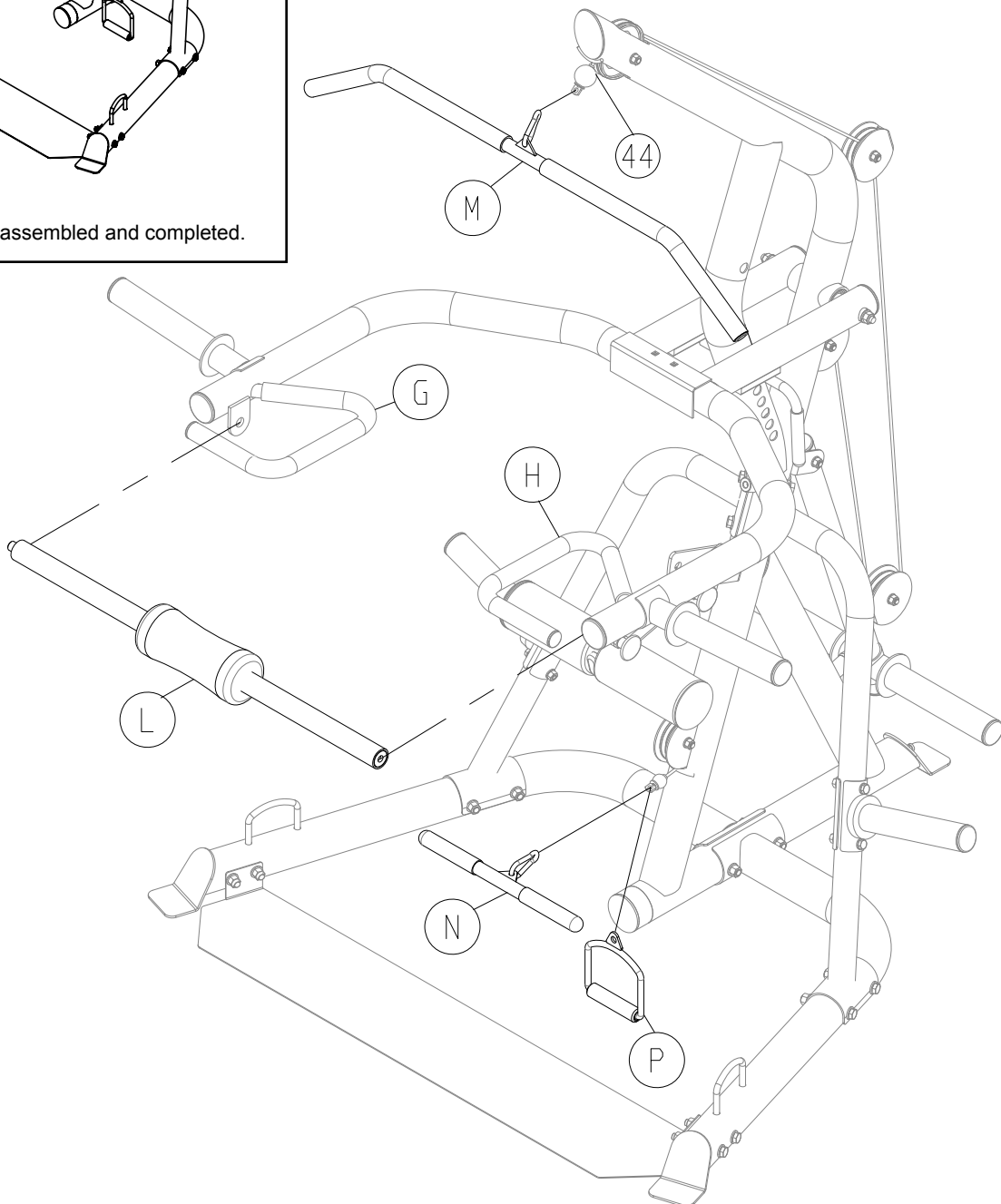

Notes

GLGS100 Exploded View

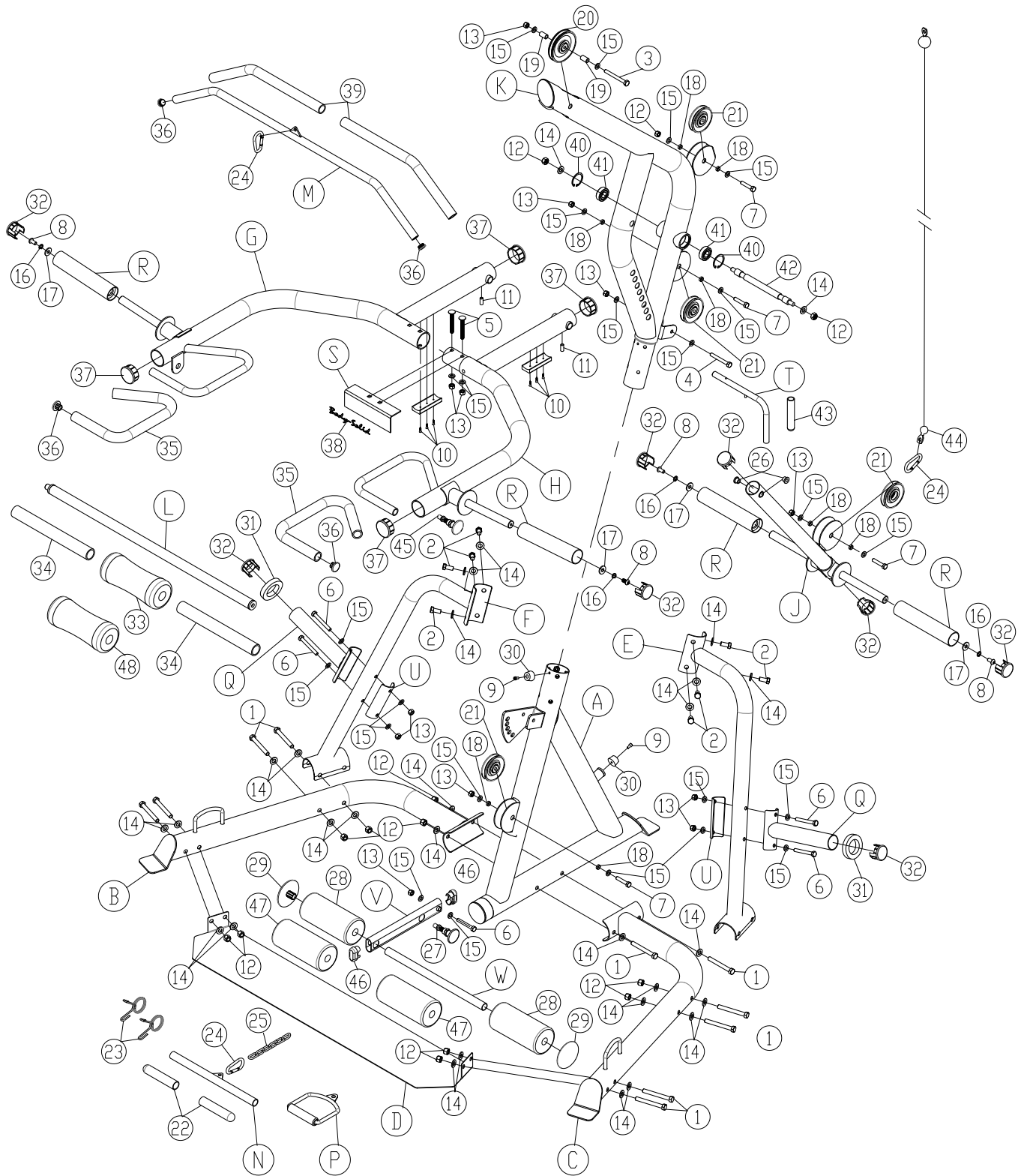



GLGS100

PLEASE WRITE YOUR SERIAL NUMBER IN THE BOXES BELOW

S/N # 009684----

1900 S. Des Plaines Ave.
Forest Park, IL 60130
Phone:(708)427-3555
Fax:(708)427-3556
Hours: M-F 8:30 - 5:00 CST

www.bodysolid.com